

EK-Quantum Momentum ROG Strix X299-E Gaming II D-RGB

MONOBLOCK

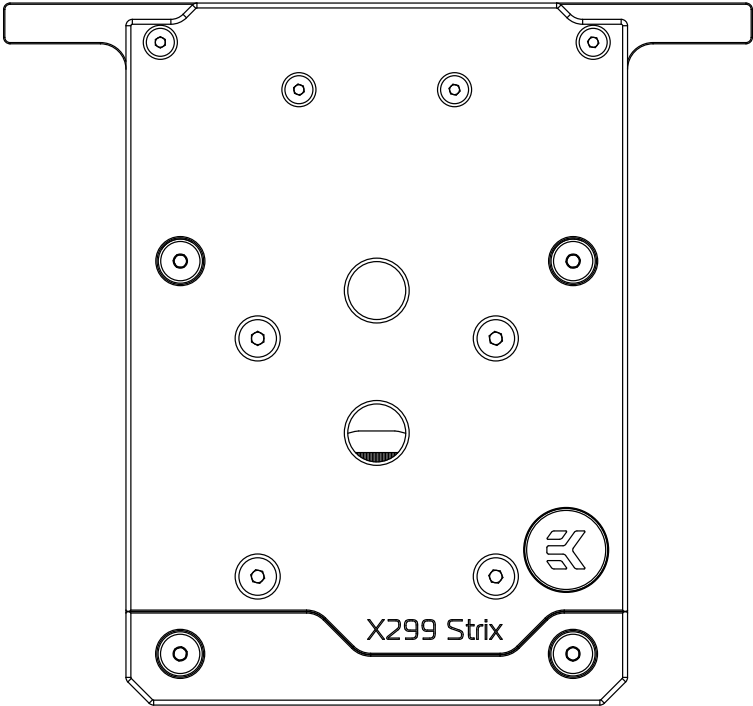

This product is intended for installation only by expert users. Please consult with a qualified technician for installation. Improper installation may result in damage to your equipment. EK Water Blocks assumes no liability whatsoever, expressed or implied, for the use of these products, nor their installation. The following instructions are subject to change without notice. Please visit our web site at www.ekwb.com for updates. Before installation of this product please read important notice, disclosure and warranty conditions printed on the back of the box.

Before you start using this product please follow these basic guidelines:

Please carefully read the manual thoroughly before beginning with the installation process!

Please remove your motherboard from the computer to assure safest mounting process in order to prevent any possible damages to your CPU and/or motherboard's circuit board (PCB).

The EK- Fittings require only a small amount of force to screw them firmly in place since the liquid seal is ensured by the rubber o-ring gaskets.

The use of quality, market proved corrosion inhibiting coolants is always strongly recommended for any liquid cooling system.

TABLE OF CONTENT

| | |
|--|----------|
| PREPARING YOUR MOTHERBOARD | 4 |
| APPLYING THERMAL COMPOUND | 5 |
| CUTTING THERMAL PADS | 5 |
| PLACING THERMAL PADS ON THE MOTHERBOARD | 5 |
| PLACING THE BLOCK ON TO MOTHERBOARD | 6 |
| ATTACHING BLOCK ON THE MOTHERBOARD | 6 |
| REQUIRED TOOLS | 8 |
| CONNECTING THE D-RGB LED STRIP | 8 |
| SUPPORT AND SERVICE | 9 |
| SOCIAL MEDIA | 9 |

PREPARING YOUR MOTHERBOARD

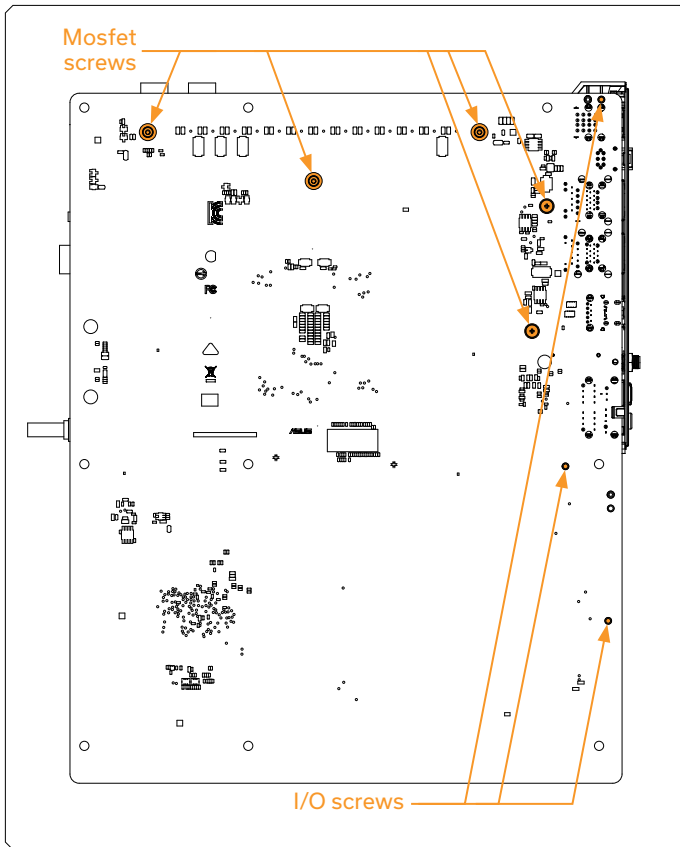

Mosfet Part:

Remove all encircled screws. There are five (5) screws on the back of the motherboard that needs to be removed in order to remove the factory provided MOSFET cooling solution.







I/O Cover:

After removing Mosfet part, remove three (3) screws and take off the I/O Plastic cover.

Store away the I/O Cover and screws as it will be reused.

BAG CONTENT

Bag content is universal for all water blocks, you may not need all screws.

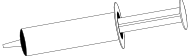
| | | |
|---|---|---|
| SA washer 3 pcs | M2.5 x 7 AX1 3 pcs | M 2.5 PVC washer 3 pcs |
|  |   |  |
| M2.5 x 5 AX1 3 pcs | M 3 PVC washer 5 pcs | Thermal Grease 1 pcs |
|   |  |  |

Replacement mounting mechanism - EAN: 3830046992956

APPLYING THERMAL COMPOUND

Apply thermal compound on CPU heat spreader (IHS) with enclosed EK-TIM EctoTherm thermal grease.

The quantity of about two rice grains is just about right. There is no need to cover the whole IHS. Applying too much thermal grease will have negative impact on the cooling performance!

CUTTING THERMAL PADS

Your block comes with thermal pads which needs to be trimmed in order to fit the voltage regulation area (MOSFET) on the motherboard's circuit board.

1. Thermal PAD F 1,0mm - (120x16mm) EAN: 3830046996732



WARNING: Dimensions on pictures below are scaled.

PLACING THERMAL PADS ON THE MOTHERBOARD

Place thermal pads on PCB as shown on the picture.



Please remove the protective foil from both sides of the thermal pads prior to installation!

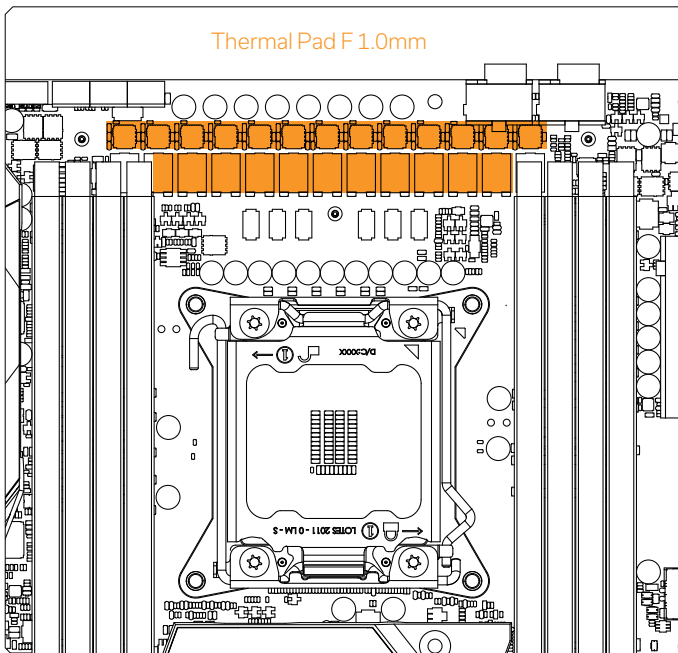
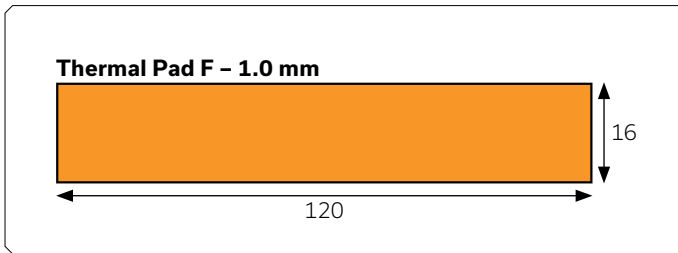

PLACING THE BLOCK ON TO MOTHERBOARD

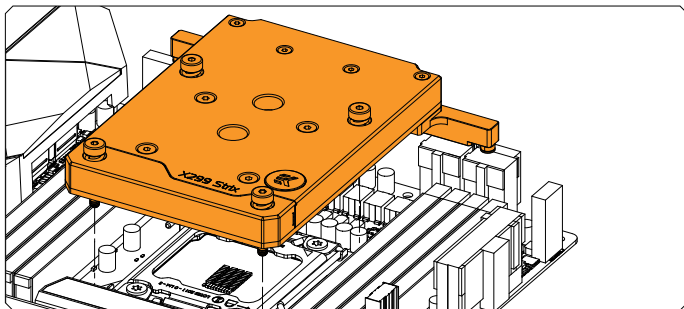

Place the EK-Quantum Momentum ROG Strix X299-E Gaming II series water block to the motherboard or vice versa (as shown on the photo). Make sure that mounting holes are aligned.

ATTACHING BLOCK ON THE MOTHERBOARD

STEP 1

Prior to fastening the screws please make sure the mounting holes on the motherboard's circuit board are aligned with the water block.

CPU part: Carefully tighten all the marked screws carefully using 2.5 mm Allen Key. Do not use excessive force.

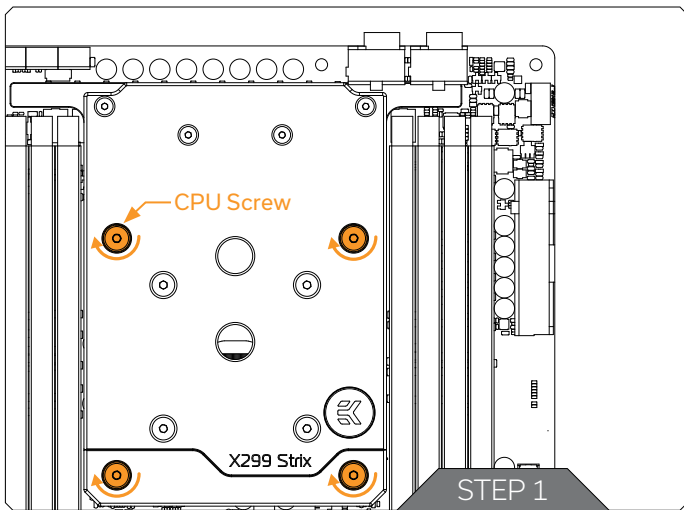

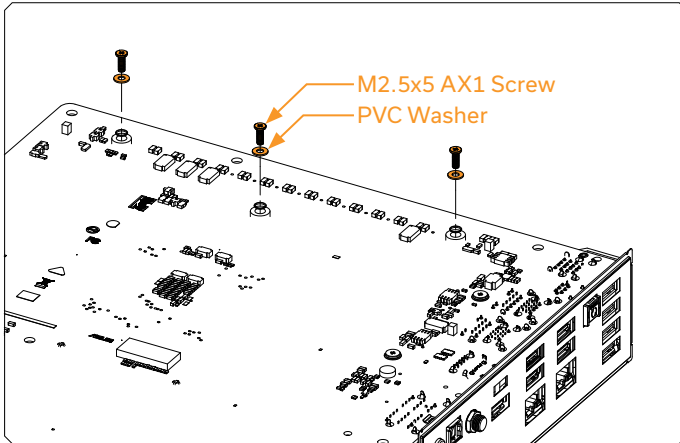

Mosfet part: Use three (3) M2.5 X 5 AX1 Screws and PVC washers. Tighten the screws evenly.

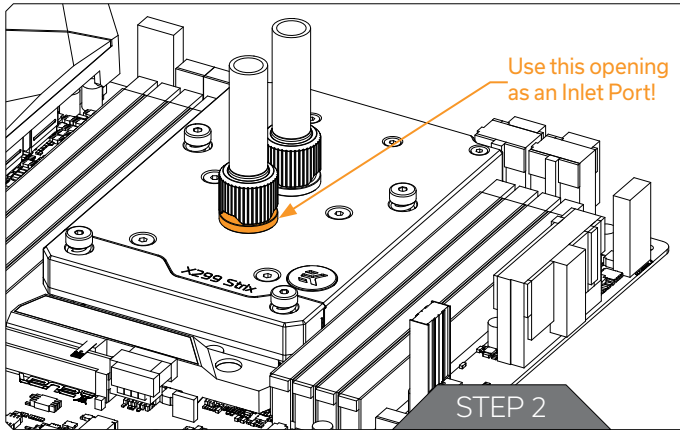

STEP 2

EK recommends the use of EK-Fittings. When using fittings other than EK series please use hose clamps or appropriate substitute to secure the tubing to the barb. The use of biocide containing and corrosion inhibiting coolant is always recommended for any liquid cooling system.

CONNECTING THE D-RGB LED STRIP

Plug the 3-pin connector from Monoblock D-RGB LED strip to the motherboard.



Please ensure that the arrow indicated on the connector is plugged into the +5V line as indicated on your motherboard. Failure to do so will damage your motherboard or LED strip.

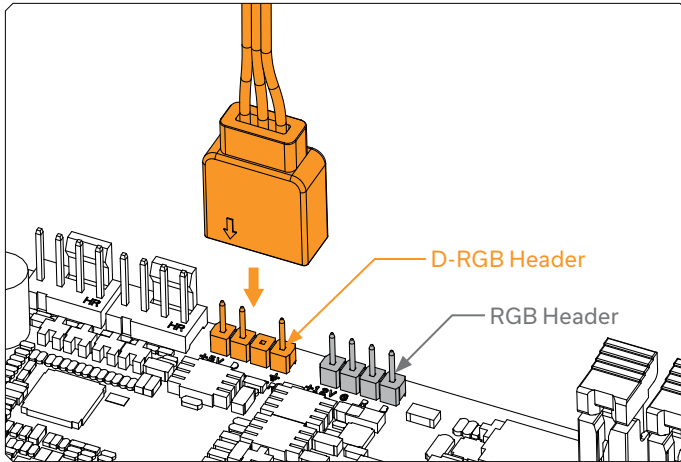

REQUIRED TOOLS

Phillips-head screwdriver

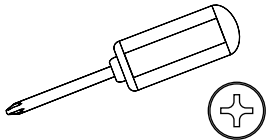

Scissors

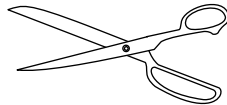

Allen Key

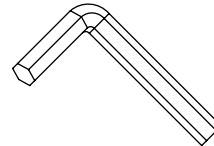

SUPPORT AND SERVICE

For assistance please contact:

<http://support.ekwb.com/>

EKWB d.o.o.
Pod lipami 18
1218 Komenda
Slovenia - EU

SOCIAL MEDIA

 EKWaterBlocks

 @EKWaterBlocks

 ekwaterblocks

 EKWBofficial

 ekwaterblocks

