

A (x1)

B (x1)

C (x1)

D (x1)

E (x1)

F (x1)

G (x1)



H (x3)



I (x2)
M3.5x10



J (x2)
M6x8



K (x2)
M6x10



L (x1)
M8x30



M (x1)
4mm



N (x1)
5mm



M-A (x4)
M4x12



M-B (x4)
M5x12



M-C (x4)
D5

1a Встановлення зажиму

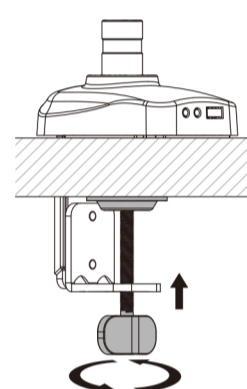
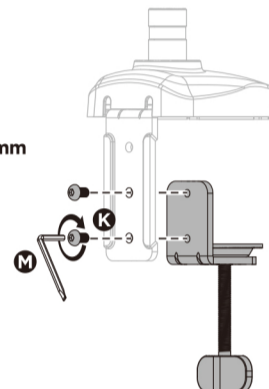
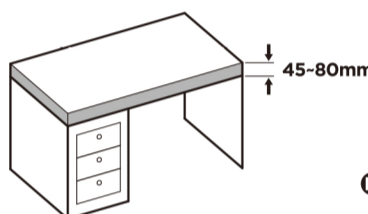
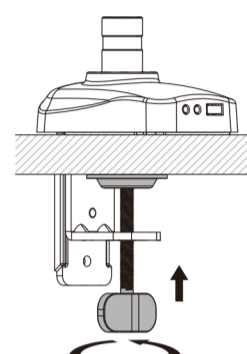
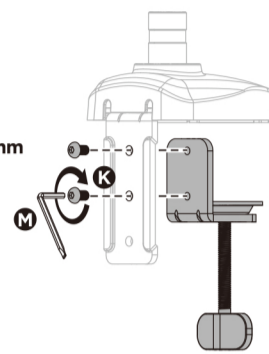
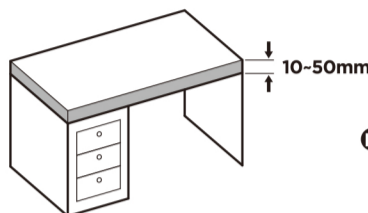
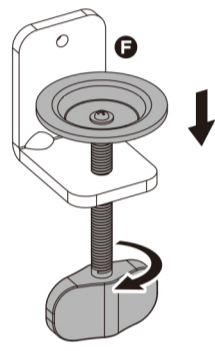
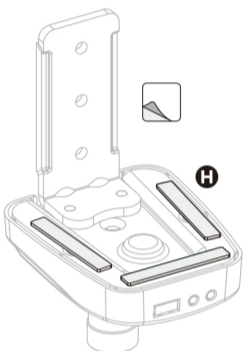
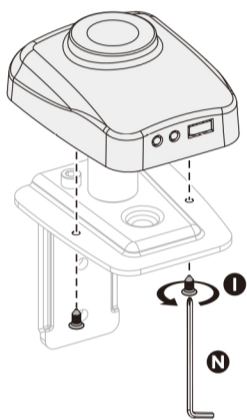
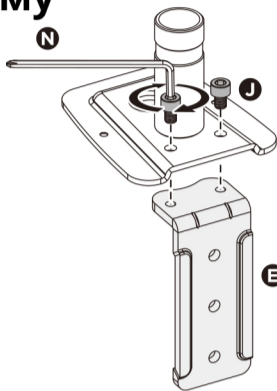
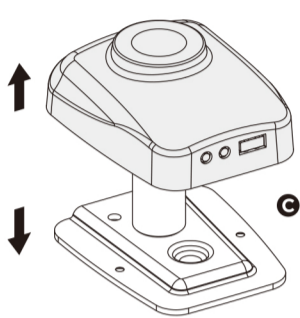

1b Монтаж кріплення

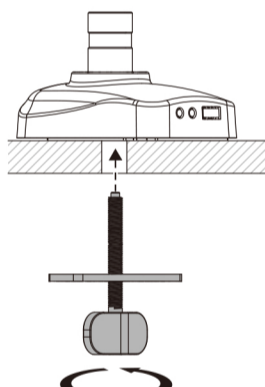
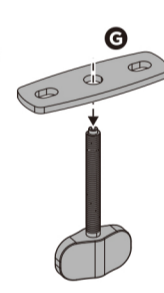
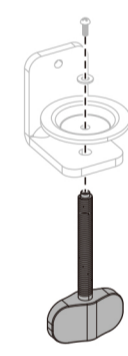
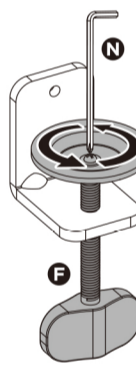
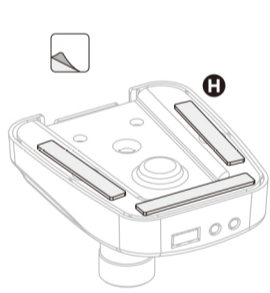
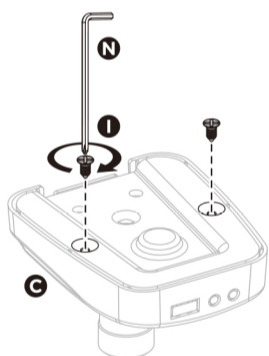
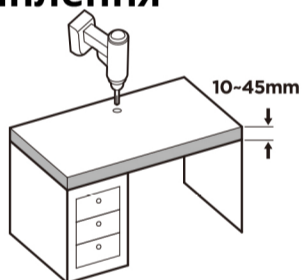
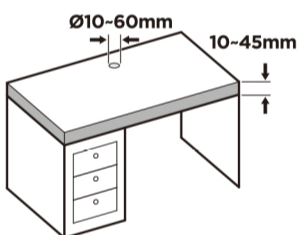

Стільниця з наявним отвором.

Ø10mm (Ø3/8")

2

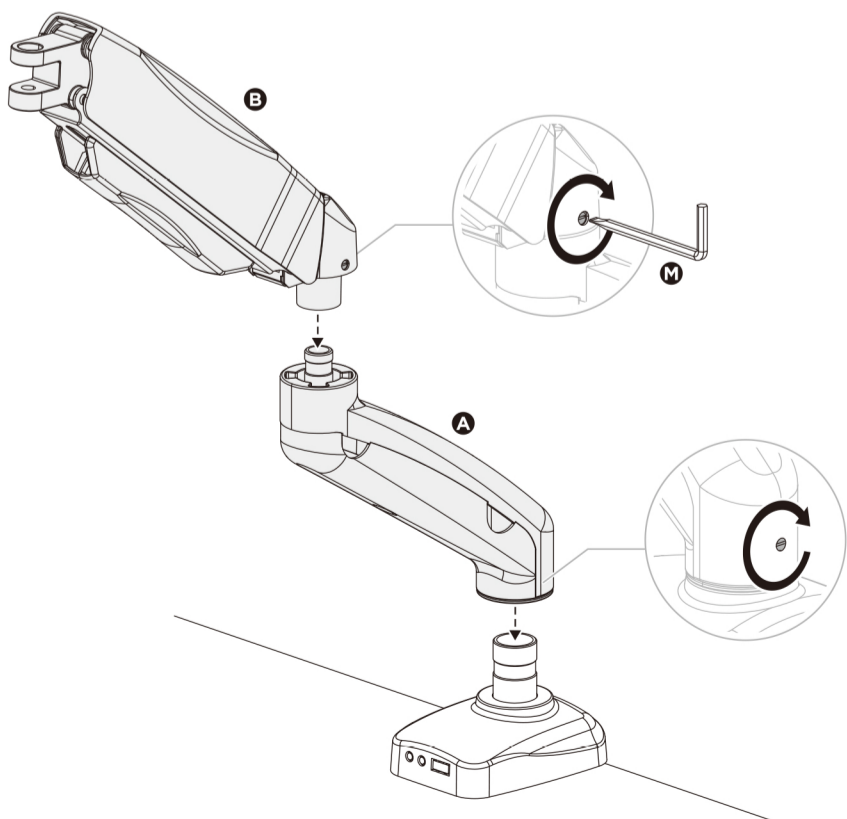

3

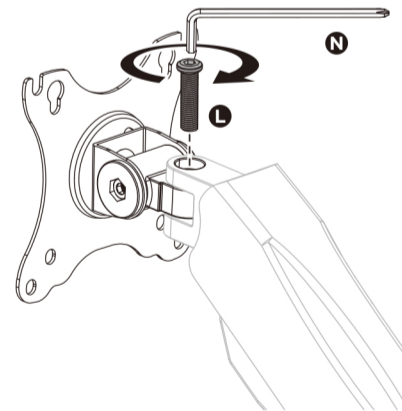
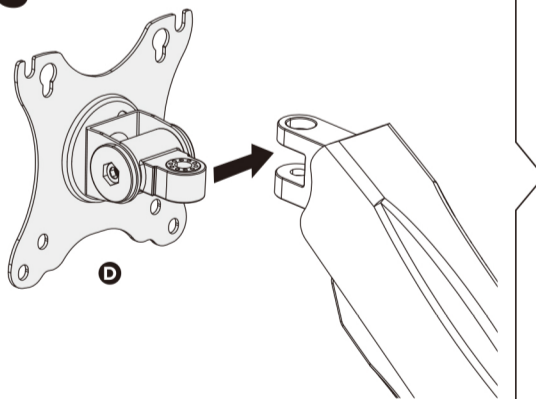

4

