

Solar Lithium Battery Energy Storage System

User Manual

Version: 1.0

Floor Mounted Lifepo4 battery 51.2v 320Ah -16.38kwh

Model No : GSL-051320A-B-GBP2 (IP65)

For On / Off Hybrid Solar Storage System

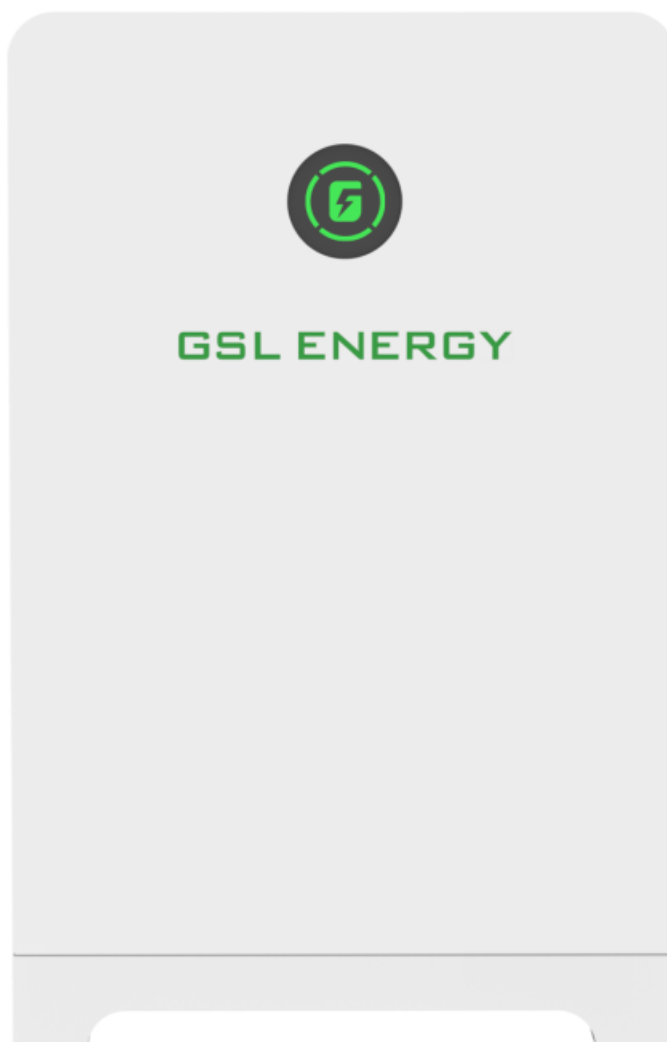

Contents

1.Safety Precautions	- 3 -
1.1 Before Connecting	- 3 -
1.2 During operation	- 3 -
2.Battery Details	- 4 -
2.1 Battery Product Label	- 4 -
2.2 Dangerous label	- 5 -
2.3 Battery Specifications	- 5 -
3. Introduction to the battery	- 6 -
3.1 Key Features	- 6 -
3.2 Interface Introduction	- 7 -
3.2.1 Communication interface	- 7 -
3.2.2 BMS internal grid connection & monitoring	- 8 -
3.2.3 Communication applications	- 9 -
3.3 SOC Indicator & Status Indicator Guides	- 10 -
3.4 Connectors	- 11 -
3.5 Wake Up button	- 11 -
3.6 Heating function	- 12 -
4. Safe handling of lifepo4 battery guide	- 13 -
4.1 Tools	- 13 -
4.2 Safety Gear	- 13 -
5.Installation	- 14 -
5.1 Standard package list items	- 14 -
5.2Installation Location	- 15 -
5.2.1 Minimum clearances	- 15 -
5.3 Installing the Battery Pack	- 16 -
5.3.1 Mechanical Installation --Mounting to a wall	- 16 -
5.3.2 Electrical Installation	- 17 -
5.3.3 Connect the battery to the ground cable	- 17 -
5.3.4 Inverter Connection	- 18 -
5.3.5 How to connect Inverter	- 18 -
5.3.6 Connection of Communication Interface	- 20 -
5.3.7 Parallel use of battery	- 22 -
5.3.8 Battery Module DIP switch definition and description	- 23 -
5.3.9 Battery parameter settings on the inverter	- 25 -
5.3.10 Register on the website after installation	- 26 -
6.Use, maintenance and troubleshooting	- 27 -
6.1 Battery system usage and operation instructions	- 27 -

6.2 Alarm description and processing - 32 -
6.2.1 Alarm and countermeasure for affecting system output - 32 -
6.2.2 Alarm and countermeasure for non-affecting system output - 32 -
6.2.3 Analysis and treatment of common faults - 33 -
7.GSL Smart ESS APP Instructions..... - 34 -
7.1 Registration..... - 34 -
7.2 Create a Plant..... - 34 -
7.3 Add a Logger..... - 35 -
7.4 Network Configuration..... - 35 -

1.Safety Precautions

- It is very important and necessary to read the user manual carefully before installing or using the battery. Failure to follow any of the instructions or warnings in this document can result in electrical shock, serious injury, death, or may damage the battery and the whole system.
- If the battery is stored for a prolonged time, it is requirement that they are charged every three to six months, and the SOC should be no less than 80%.
- The battery needs to be recharged within 12hours, after fully discharging.
- Do not expose cable outside.
- All battery terminals must be disconnected before maintenance.
- Do not use cleaning solvents to clean the battery.
- Do not expose the battery to flammable or harsh chemicals or vapors.
- Do not paint any part of the battery, include any internal or external components.
- Do not connect battery with PV solar wiring directly.
- Any foreign object is prohibited to be inserted into any part of the battery.
- Any warranty claims are excluded for direct or indirect damage due to items above.

1.1 Before Connecting

- After unpacking, please check the battery and packing list first, if the battery is damaged or spare parts are missing, please contact the dealer.
- Before installation, be sure to cut off the grid power and make sure the battery is in the turned-off mode;
- Wiring must be correct, do not mix-connect the positive and negative cables, and ensure no short circuit with the external device;
- It is prohibited to connect the battery with AC power directly;
- The embedded BMS in the battery is designed for 51.2VDC, please DO NOT connect battery in series;**
- It is prohibited to connect the battery with different type of battery;**
- Please make sure battery SOC and Voltage should be the same level before paralleling two more batteries together.**
- Please ensure the electrical parameters of battery system are compatible to inverter;
- Keep the battery away from fire or water.

1.2 During operation

- If the battery system needs to be moved or repaired, the power must be cut off first and the battery is completely shutdown;
- It is prohibited to connect the battery with different type of battery;
- It is prohibited to put the batteries working with faulty or incompatible inverter;
- In case of fire, only dry powder fire extinguisher can be used, liquid fire extinguishers are prohibited;
- Please do not open, repair or disassemble the battery. We do not undertake any consequences or related responsibility due to violation of safety operation or violating of design, production and equipment safety standards.

2. Battery Details

2.1 Battery Product Label

Solar Lithium Battery Energy Storage System	
Battery Type	LiFePO4 Battery
Battery Model	GSL051320A-B-GBP2
Battery Power	16.38KWh
Battery Voltage	51.2V
Capacity of Battery	320Ah
Charge Voltage	56V
Discharge Voltage	46V
Max Charge Current	≤150A
Max Discharge Current	≤150A
Short Circuit Protection Current	1652A (106mS)
Depth of Discharge	80% DOD
Display	LCD/LED
Communication	CANBUS/RS485
Degree of Protection	IP65

Manufacturing Date: YYYY/MM/DD



CAUTION		CAUTION	
	DO NOT PUT HANDS INTO SAFETY GUARD WHEN MACHINE IS WORKING.		VOLTAGE ALSO PRESENT WHEN MASTER SWITCH IS TURNED OFF.

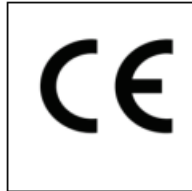

This battery product meets European directive requirements



Read the user manual before using



After the battery life is terminated, the battery can continue to be used after it recycled by the professional recycling organization and do not discard it at all

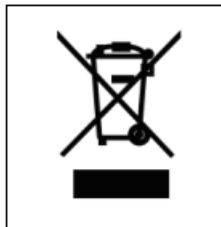

The scrapped battery cannot be put into the garbage can and must be professionally recycled.



Keep battery far from fire-easy flammable and explosive materials.

Be careful with your actions and be aware of dangers

2.2 Dangerous label

WARNING AVERTISSEMENT



1. Do not disassemble or alter the battery in any way.
Ne démontez ni modifiez la batterie en aucune façon.
2. Do not use the battery for purposes not described in its documentation.
N'utilisez pas la batterie à des fins non décrites dans sa documentation.
3. Do not drop, strike, puncture, or step on the battery.
Ne laissez pas tomber, ne heurtez pas, ne percez pas et ne marchez pas sur la batterie.
4. In case of electrolyte leakage, keep leaked electrolyte away from contact with eyes or skin, immediately clean with water and seek help from a doctor.
En cas de fuite d'électrolyte, évitez tout contact de l'électrolyte qui fuit avec les yeux ou la peau, nettoyez immédiatement avec de l'eau et demandez de l'aide à un médecin.
5. Do not put the battery into a fire. Do not use it or leave it in a place near fire, heaters, or high temperature sources.
Ne mettez pas la batterie au feu. Ne l'utilisez pas et ne la laissez pas à proximité de feux, de radiateurs, ou de sources de températures élevées.
6. Do not submerge the battery in water, or expose it to moisture.
Ne plongez pas la batterie dans l'eau et ne l'exposez pas à l'humidité.
7. Do not allow the terminals to contact exposed wire or metal.
Ne laissez pas les bornes entrer en contact avec du fil ou du métal exposé.
8. The battery is heavy and can cause injury if not handled safely.
La batterie est lourde et peut provoquer des blessures si elle n'est pas manipulée en toute sécurité.
9. Keep out of reach of children or animals. Tenir hors de portée des enfants ou des animaux.

2.3 Battery Specifications

Battery Specifications	
Model No	GSL-051320A-B-GBP2
<i>Nominal Parameters</i>	
Nominal Voltage	51.2V
Rated Capacity	320Ah
Energy	16.38kWh
Dimensions (L x W x D)	1050*700*200mm / 41.3*27.6*7.8in
Weight	143kg / 315lbs

Electrical Parameters	
Max. discharge voltage of battery	56VDC
End of discharge voltage of battery	46VDC
Maximum charge current of battery	150A
Maximum discharge current of battery	150A
Charging temperature range of battery	0-55°C
Discharge temperature range of battery	-20- 55°C
Number of cells in battery pack	16S1P
Lithium Battery Standard	UL1973, UL9540A,CB-IEC62619CE-EMC, UN38.3, MSDS
Enclosure protection rating	IP65

3. Introduction to the battery

3.1 Key Features

- LiFePO₄ composition – provides exceptional safety and longevity
- High safety and reliability
- Over 6,000cycles
- Consistent performance over wide temperature range
- Wall-mounted, convenient installation
- Integrated state-of-the-art BMS to manage and monitor battery information including voltage, current and temperature as well as balance cell charging/discharging rates
- 10 years' warranty

3.2 Interface Introduction

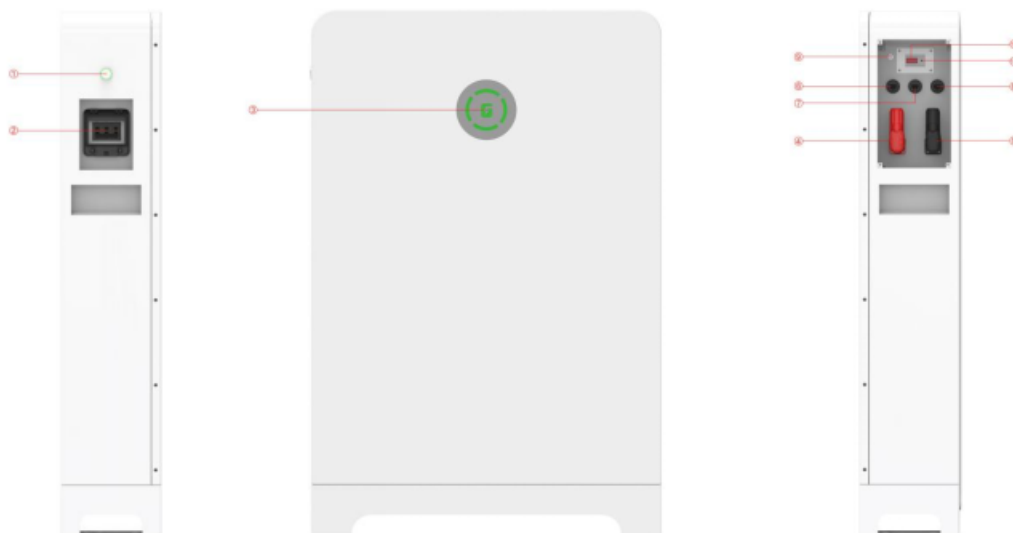

No.	Description	Silk-screen	Remark
1	Power Switch	ON/OFF	
2	DC Breaker	ON/OFF	300A Breaker
3	LED indicator	SOC/ALM/RUN	Running State
4	Battery Positive	+	
5	Battery Negative	-	
6	CAN/RS485	CAN/RS485	Connecting battery to Inverter
7	RS485A	RS485A	Parallel function or connecting smart BMS software with computer
8	RS485B	RS485B	Parallel function or connecting smart BMS software with computer
9	Ground Connection		
10	DIP ADDRESS	ADD	8 PINS Number
11	RESET	RST	Restart function

3.2.1 Communication interface

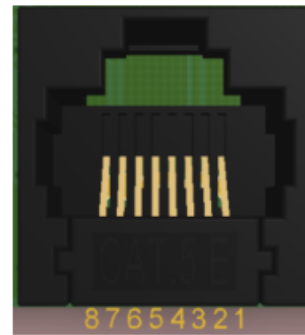

CAN&RS485

BMS and inverter communication connection

CAN - with 8P8C vertical RJ45 socket		RS485- with 8P8C vertical RJ45 socket	
RJ45Pins	Definition notes	RJ45Pins	Definition notes
4,	CANH	1、 8,	RS485-B2
5,	CANL	2、 7,	RS485-A 2
		3、 6,	GND

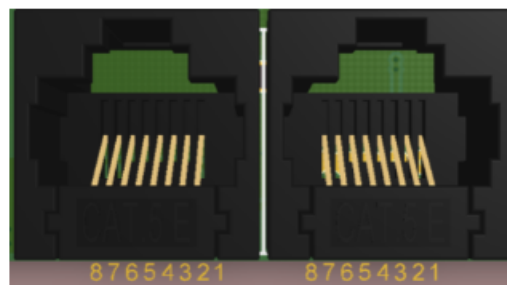

RS485-A/RS485-B

3.2.2 BMS internal grid connection & monitoring

RS485_A/B - with 8P8C vertical RJ45 socket		RS485_A/B - with 8P8C vertical RJ45 socket	
RJ45 Pins	Definition notes	RJ45 Pins	Definition notes
1、 8、	RS485-B1	1、 8、	RS485-B1
2、 7、	RS485-A1	2、 7、	RS485-A1
3、 6、	GND	3、 6、	GND
4、 5、	NC	4、 5、	NC

3.2.3 Communication applications

✚ RS485 Stand-alone mode connection

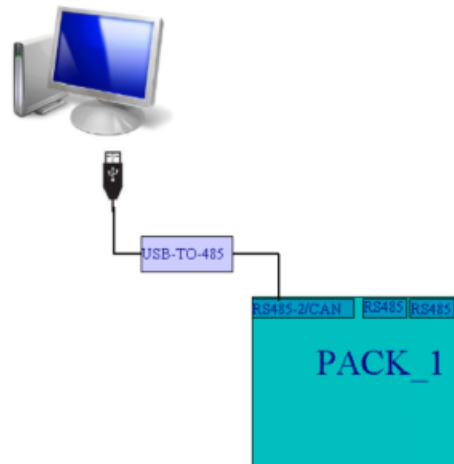

✚ RS485-A/B As master, CAN with inverter, 485-A/B as slave mode parallel communication

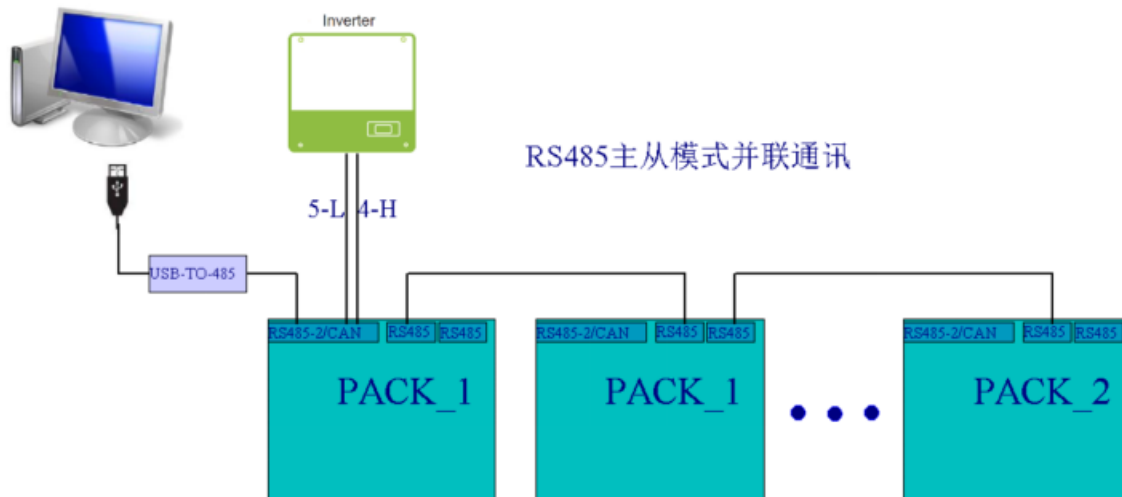

Note : Monitoring of battery system performance is achieved via inverter monitoring portal/app

3.3 SOC Indicator & Status Indicator Guides

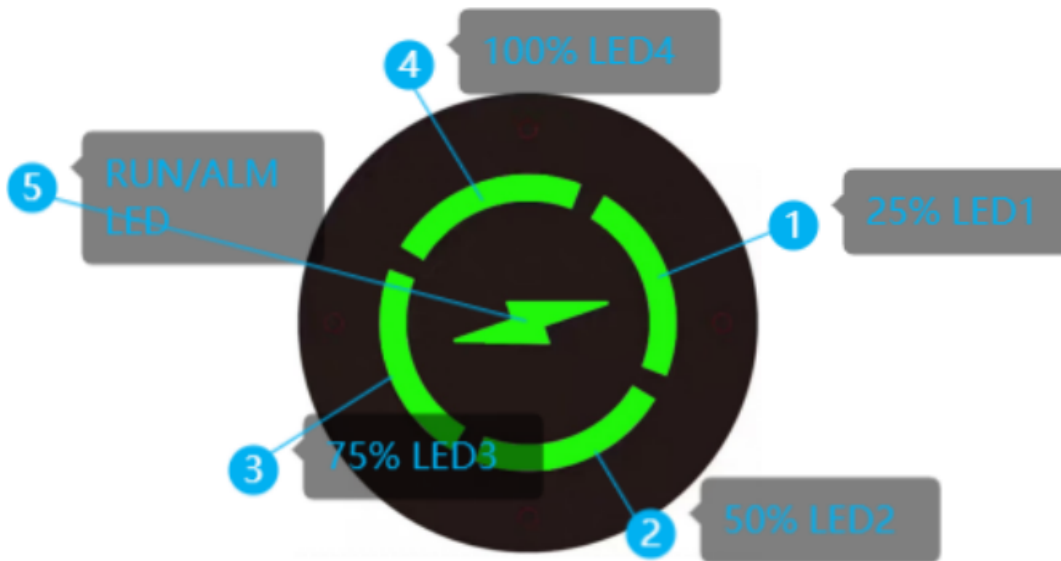

Battery status		SOC				ALM/RUN
turn off	BMS SOC and status	25% LED1	50% LED2	75% LED3	100% LED4	ALM/RUN Lightning LED
Charge	0%	●	●	●	●	⚡
	1%-25%	★				★
	26%-50%	●	★			★
	51%-75%	●	●	★		★
	76%-100%	●	●	●	★	★
	100%	●	●	●	●	★
Discharge	100%-76%	●	●	●	★	●
	75%-51%	●	●	★		●
	50%-26%	●	★			●
	25%-1%	★				★
	0%	★★				★
Alarm		/	/	/	/	★
Protection		/	/	/	/	●
Fault		/	/	/	/	●

3.4 Connectors



Charge / Discharge connectors: to connect the positive pole (+) and negative pole (-) from the battery to the inverter via DC isolator.

Canbus/485 active communication port between battery and inverter.

USB to RS485: to get dynamic monitoring data of the battery from upper computer.

Address: Reserved Address portal for multiple parallel connections.

3.5 Wake Up button

- Battery On: When battery is shut down, press this RST button for 3 seconds. It is activated when the LED lights flicker from RUN light to the lowest capacity indicator.
- Battery off: When battery is activated, press this button for 3 seconds. It will be shut down when the LED lights flicker from lowest capacity indicator to RUN light.



3.6 Heating function (optional)

Battery charging in a low-temperature environment is easy to form lithium deposits on the surface of the negative electrode, the accumulation of lithium metal on the surface of the negative electrode will puncture the battery diaphragm causing a short circuit of the battery's positive and negative electrodes, which threatens the safety of battery use. In order to charge batteries in a low-temperature environment, GSL has introduced batteries with the function of heating film.

- A description of the GSL battery heating function:

1. The power of heating film is about 100w, the working voltage is 48V, and the working current is 2A.
2. The heating function is a charge enable and is only turned on when the battery is charged.
3. Heating function does not activate when the battery is discharged or in a standstill state

- How does heating film work?

When the battery temperature reaches the low-temperature protection (0 °C) battery charging demand, the heating film to open the heating, at this time the battery BMS prohibit charging to the battery, but the heating film will be from the inverter or charger and other external access to electrical energy to heat the battery cell, at this time the temperature of the battery cell temperature temperature rise (due to the heating position is located in a certain part of the battery, through heat conduction to reach each temperature sensation takes time, the temperature rise of the battery cell may be relatively slow). When heated to the battery cell temperature reaches the charging low temperature warning temperature (5 °C), the battery starts charging, at this time the charging current is the current limiting strategy current of the battery BMS (0.2C or more), when heated to the battery cell temperature of 10 °C, the heating film stops heating, the heating function is turned off.

4. Safe handling of lifepo4 battery guide

4.1 Tools

The following tools are required to install the battery pack:



Wire cutter



Crimping Modular Plier



Screw Driver

NOTE

- Use properly insulated tools to prevent accidental electric shock or short circuits.
- If insulated tools are not available, cover the entire exposed metal surfaces of the available tools, except their tips, with electrical tape.

4.2 Safety Gear

It is recommended to wear the following safety gear when dealing with the battery pack:



Insulated gloves



Safety goggles







Safety shoes

5.Installation

5.1 Standard package list items

Thoroughly inspect the packaging upon receipt of goods. If there is any item missing or if there is any damage to the external packaging or to the unit itself upon unpacking, please contact us immediately.

NO.	Item	Quantity	Specification
1	Battery Pack 	1 PC	16.38KWH
2	Power Cable 	1 SET	35mm ² (2AWG) Black , Red L 2.0 meter Push-In 200A Standard+ M10 Terminal
3	Communication Cable 	1 PC	Battery canbus port to Inverter Canbus port L : 1.5 meter
4	Parallel com cable 	1 PC	Battery com port to Battery com port for parallel 16pcs at max L: 1.0 meter
5	Ground cable 	1PC	Connect to the grounding point of the modules

5.2 Installation Location

Make sure that the installation location meets the following conditions:

- The installation site must be suitable for the size and weight of the battery.
- Must be installed on a firm surface to sustain the weight of battery.
- The area is water proof.
- There are no flammable or explosive materials in proximity
- The ambient temperature is within the range from 0°C to 45°C.
- The temperature and humidity is maintained at a constant level.
- There is minimal dust and dirt in the area.



CAUTION

If the ambient temperature is outside the operating range, the battery pack stops operating to protect itself. The optimal temperature range for the battery pack to operate is 0°C to 45°C. Frequent exposure to harsh temperatures may deteriorate the performance and life of the battery pack.

5.2.1 Minimum clearances

Observe the minimum clearances to walls, other batteries or objects as shown in the diagram and picture below in order to guarantee sufficient heat dissipation

Direction	Minimum clearance (mm)
Above	300
Sides	500
Front	300

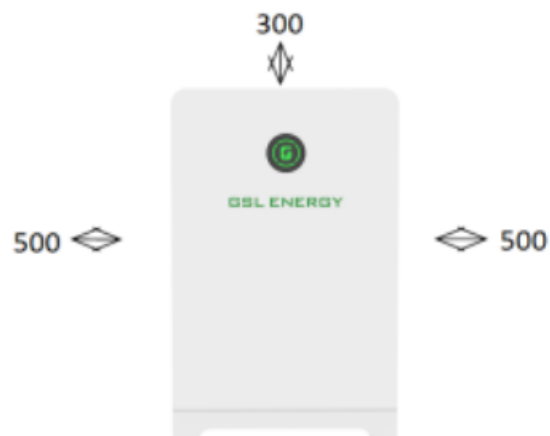

5.3 Installing the Battery Pack

5.3.1 Mechanical Installation --Mounting to the floor

 **WARNING**

In order to avoid electrical shock or other injury, inspect existing electronic or plumbing installations before drilling holes. The battery is heavy, please handle with care to avoid damage to the product or injury to the installer.

1. Choose a suitable flat and firm surface for installation.
2. Using the sheet metal holes on the bottom of the battery as a template, mark the holes on the ground.



3. Drill 4 holes according to the hole position, it is $\varnothing 10$ with depth 100mm.
4. Install the battery into the ground hole and secure it with M8 screws.



 **WARNING**

Falling equipment can cause serious or even fatal injury: never mount the inverter on the bracket unless you are sure that the mounting frame is firmly mounted on the wall after thorough checking.

5.3.2 Electrical Installation

1. Before connecting the power cables, using multi-meter to measure cable continuity, short circuit, confirm positive and negative, and accurately mark the cable labels.

2. Measuring method:

A. Power cable check: select the buzzer mode of multi-meter and detect the both ends of the same color cable. If the buzzer calls, it means the cable is in good condition.

B. Short circuit judgment: choose multi-meter resistor file, probe the same end of positive and negative pole, if the resistor shows infinity, means that the cable is available.

C. After visual testing of power line is connection, the positive and negative poles of the battery shall be connected respectively to the positive and negative poles of the opposite terminal.

5.3.3 Connect the battery to the ground cable

The Ground cable has been provided by factory manufacturer. The bolt locking torque is 6 NM.

Install a grounding cable to the grounding point of the modules.



Grounding cable:

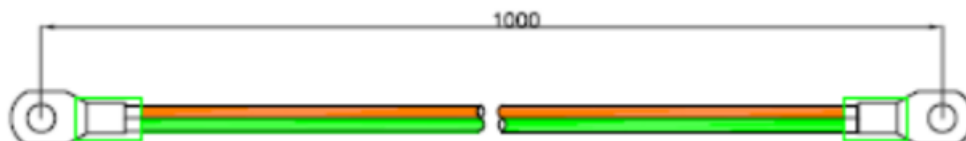

5.3.4 Inverter Connection

DIP ADDRESS SETUP (When the system is used independently): Except for the inverter specified by the customer's special requirements, the factory default DIP switch mode of master module is DIP Switch **mode 1 (ADD: 00000000)**.

Note: Before installation, please confirm whether the DIP switch mode of the master module in battery is correct according to use's inverter communication specification.

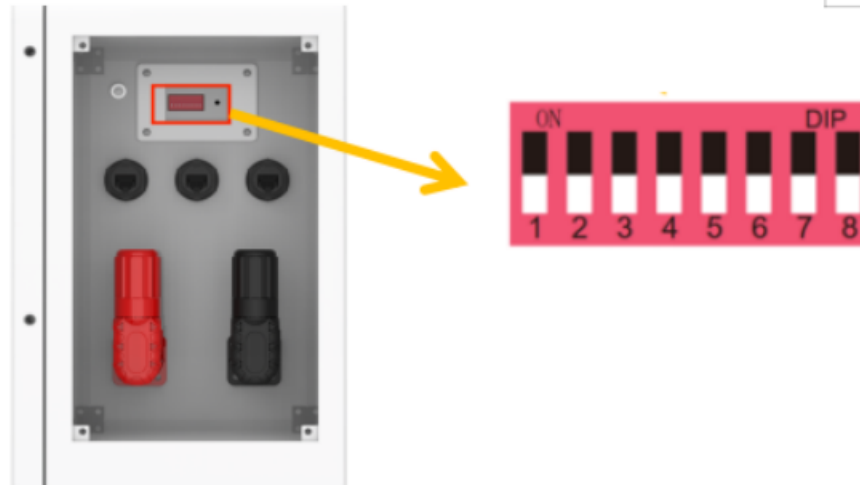

Before opening the cover to operate, you must contact GSL ENERGY and inform the ID of the product. GSL ENERGY records this battery ID and authorizes the opening operation. Except changing the DIP switch mode, no other operations can be done.

5.3.5 How to connect Inverter

The battery is connected to the inverter, and it is required to use the dedicated power cable and communication cable (as accessories shipped with the cargo, the standard communication cable is a standard network cable. The applicable inverter is marked on the label of the network cable. If the inverter used by the customer is not covered by the standard communication cable, please contact GSL ENERGY for the correct PIN Sequence) as follows:

--Keep the battery system at power off state, connect the power cable to the interface on the input side of the inverter first, and then connect the power cable to the interface on the battery side.

--The battery output interface is a quick connector, and the power cable (positive, negative) plug can be directly inserted into the battery socket. The power cable cross section is 35 mm²*2. .

Power Terminals

- Power cable terminals: there are two pair of terminals with same function, one connects to equipment, the other one paralleling to other battery module for capacity expanding.
- For power cables uses water-proofed connectors.

●Must keep pressing this Lock Button while pulling out the power plug.

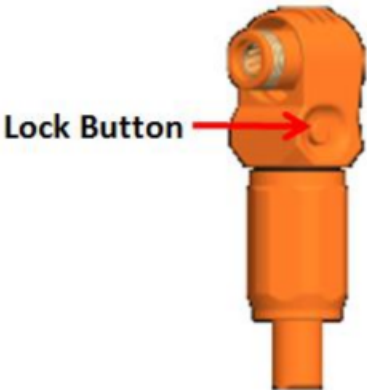

Power cables sets :

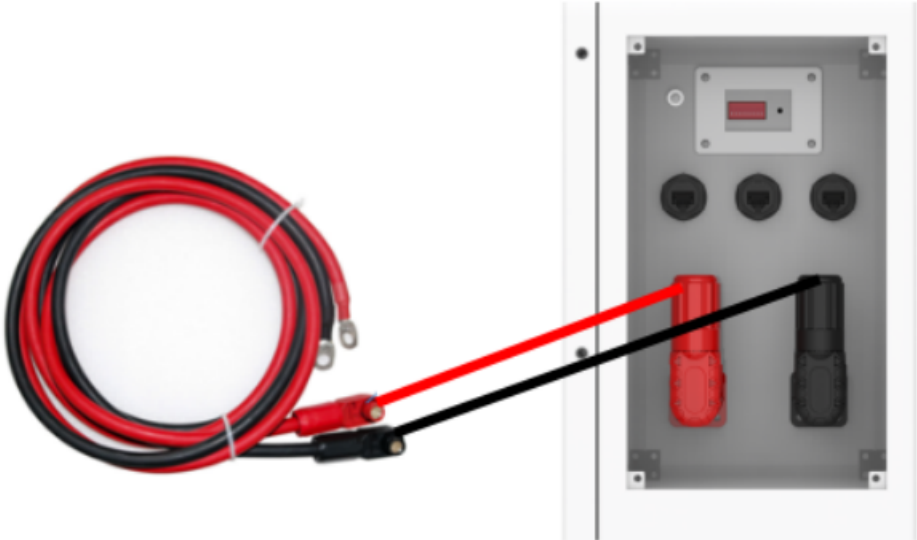
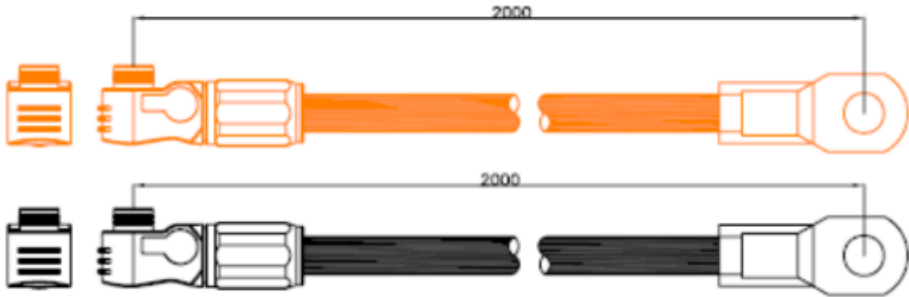

5.3.6 Connection of Communication Interface

Connect the CAN IN port of the battery to the CAN or RS485 communication interface of the inverter using the RJ45 cable.

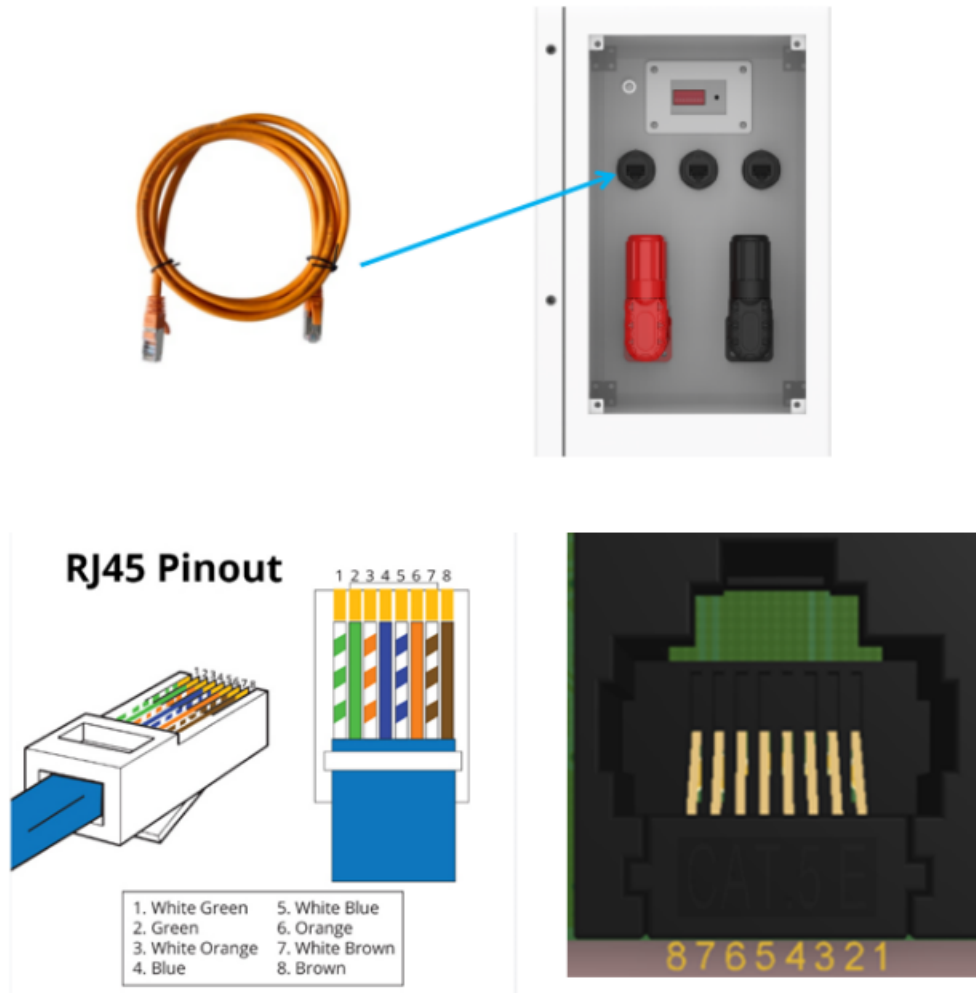

PIN Definition

Foot Position	Color	Definition
PIN 1	White Green	485B
PIN 2	Green	485A
PIN 3	White Orange	X GND
PIN 4	Blue	CAN-H
PIN 5	White Blue	CAN-L
PIN 6	Orange	Reserved
PIN 7	White Brown	XIN
PIN 8	Brown	Reserved

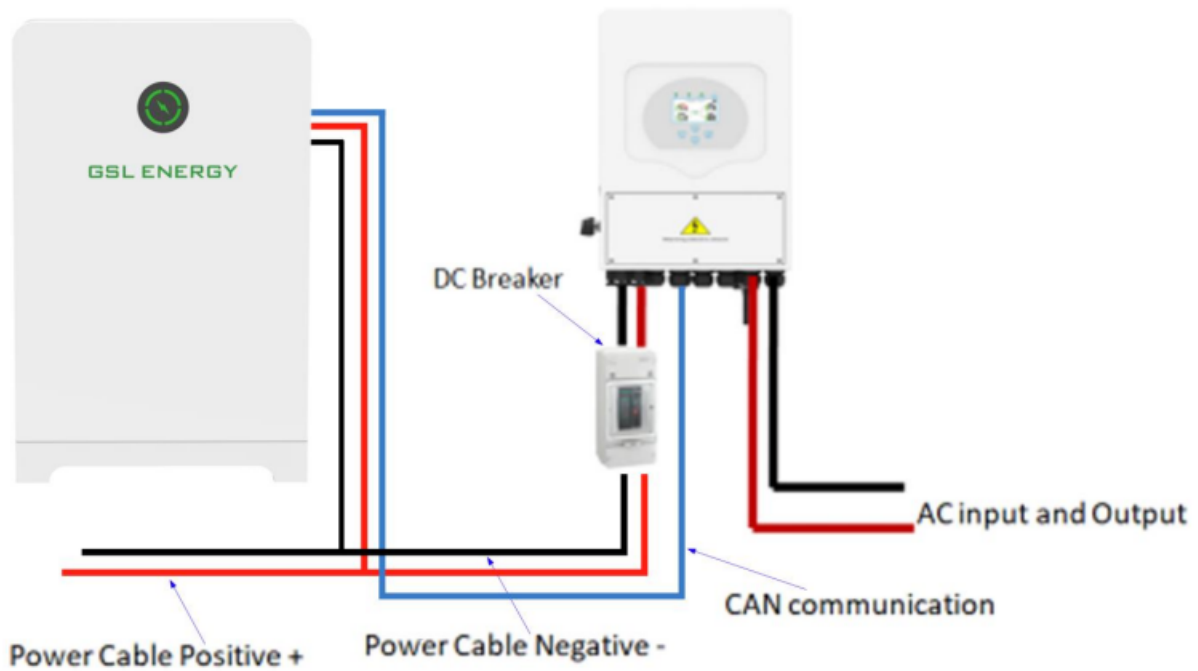

Communication cable for battery and inverter

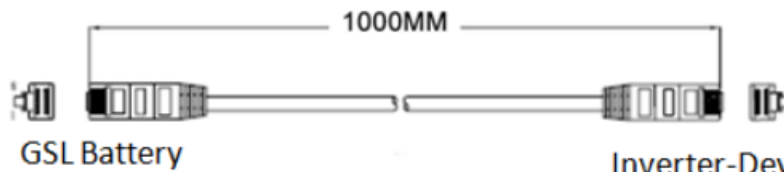

Foot Position	Color	Definition
PIN 1	White Green	485B
PIN 2	Green	485A
PIN 3	White Orange	X GND
PIN 4	Blue	CAN-H
PIN 5	White Blue	CAN-L
PIN 6	Orange	Reserved
PIN 7	White Brown	XIN
PIN 8	Brown	Reserved

↔

Foot Position	Color	Definition
PIN 1	White Green	485B
PIN 2	Green	485A
PIN 3	White Orange	X GND
PIN 4	Blue	CAN-H
PIN 5	White Blue	CAN-L
PIN 6	Orange	NC
PIN 7	White Brown	NC
PIN 8	Brown	NC

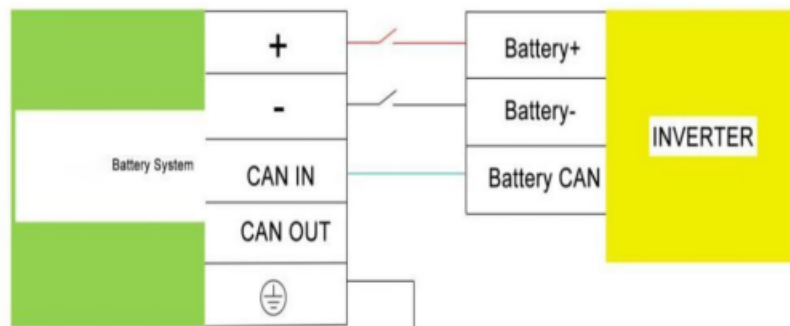

5.3.7 Parallel use of battery

When the system is used in parallel, it supports up to 16pcs wall batteries in parallel. According to the number of parallel system (Take 3 batteries in parallel as an example), it needs to use: Power cable × 3 pairs, Battery-Inverter communication cable × 1PCS, Battery-Battery communication cable × 2PCS, Distribution box × 1PCS). The over-current capacity of the distribution box should be much higher than the maximum nominal current value when the load is running

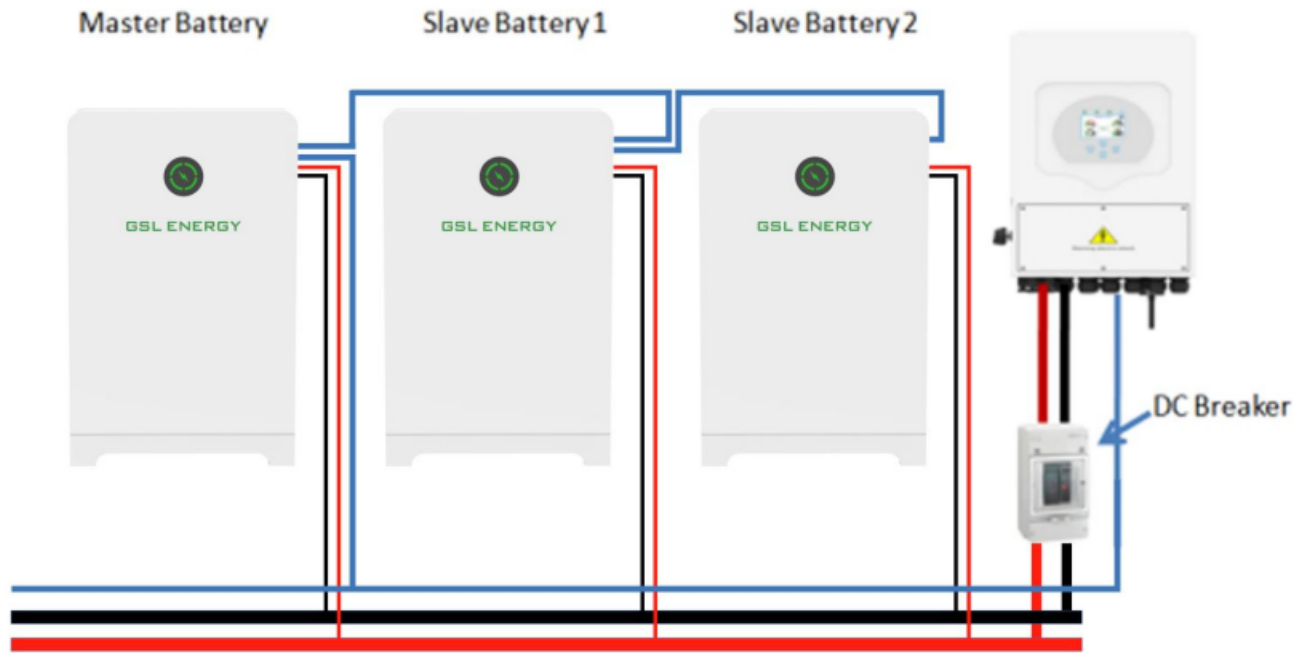

PINOUT of System Parallel communication cable

PINOUT of Battery-Battery communication cable diagram shown as below:

Communication cable for battery parallel connection

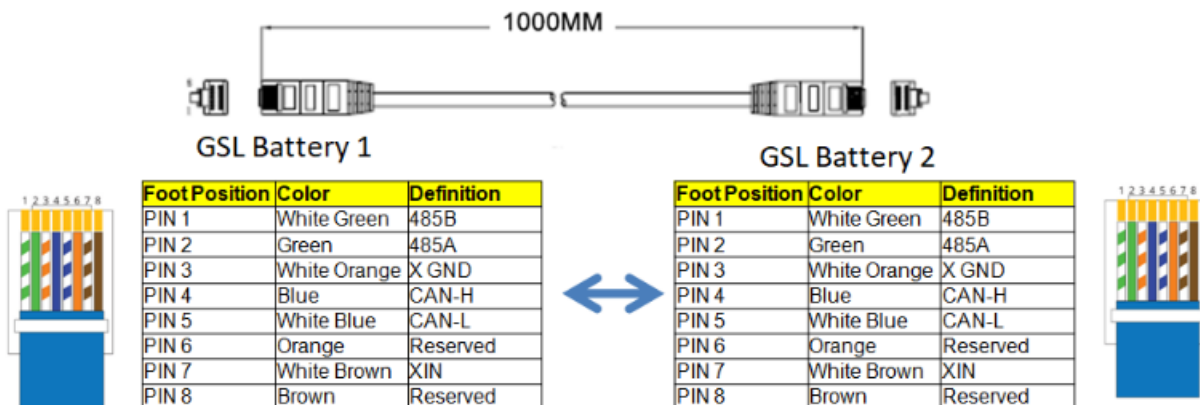

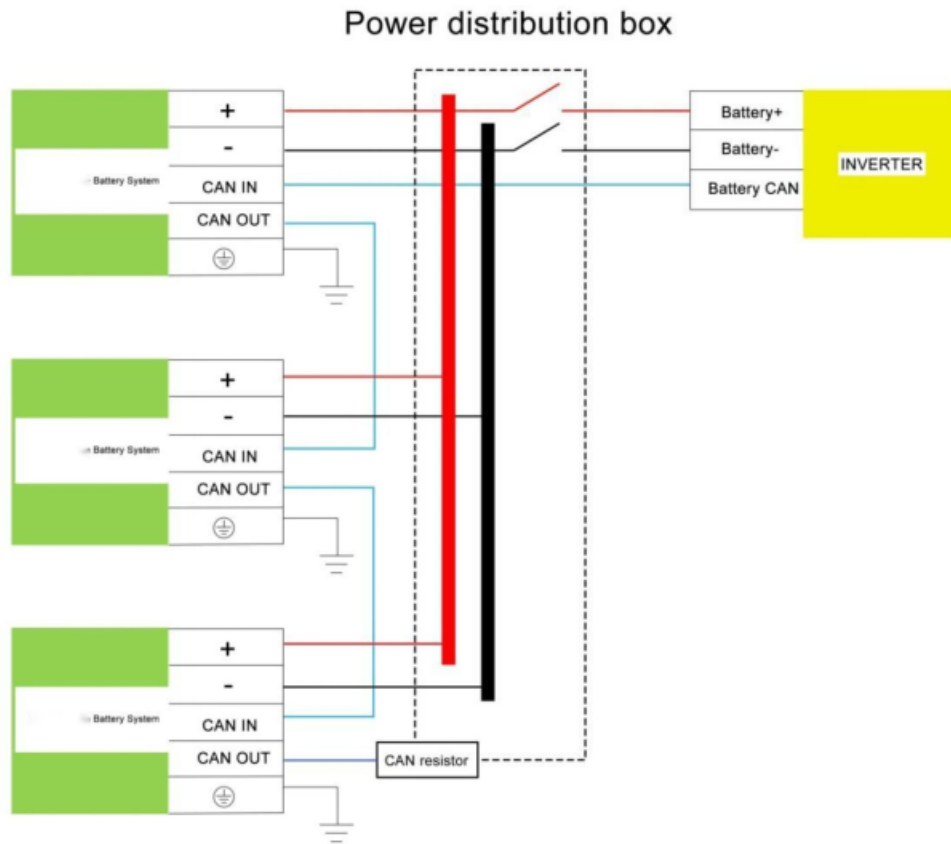

An over-current protection and isolation device that operates both positive and negative conductors simultaneously is required between parallel batteries and between the inverter and battery system.

Modifying the power cables to insert an over-current protection and isolation device between parallel batteries will not void product warranty.

5.3.8 Battery Module DIP switch definition and description.

DIP Switch Definition

DIP switch position (master communication protocol and baud rate selection)

# 1	# 2	# 3	# 4	# 5	# 6	# 7	# 8
Distinguish between master and slave				Baud rate selection	No definition	No definition	No definition
				OFF: CAN:500K, 485:9600			
				ON: CAN 250K, 485:115200			

When the batteries are connected in parallel, the master communicates with the slaves through the RS 485 interface. The master summarizes the information of the entire battery system and communicates with the inverter through CAN or 485.



Caution

- Before connection, the positive and negative pole of the inverter input interface and the battery output interface should be confirmed.
- The red power line is connected to the positive pole and the black power line is connected to the negative pole.
- Before connection, it is necessary to confirm the charge and discharge parameters of the inverter interface.
- Voltage and current should meet the requirements of Table 2-2 battery performance parameters.
Note: For more information of matching inverter brands, please subject to the latest document
- How to judge that the communication between the product is normal:
 - 1) If there is communication between the inverter and battery system, it can be judged by the maximum charge and discharge current value on the inverter sent by the battery.
 - 2) If there is communication between the inverter and battery system, it can be judged by the maximum charge and discharge current value on the inverter sent by the battery.

(The maximum charge and discharge current value display on the inverter)

= number of modules

(The maximum charge and discharge current value of one battery module)

A. If the equation holds after calculation, it means communication between the GSL battery is normal.

B. If the GSL Battery light board shows three different colors flash alternately, it means the communication between battery is fault.

- Table 3-5 Battery & Inverter power matching table

Equipment Use	Charging a) The battery's long-term continuous charging current should be $\leq 0.5C$ b) If the battery remaining capacity is empty, please charge it within 48 hours after the battery is empty.
	Discharging c) The long-term continuous discharge current of the battery should be $\leq 0.5C$ d) The recommend maximum depth of discharge (DOD) of Battery PACK is no more than 85%.

5.3.9 Battery parameter settings on the inverter

Max Charging(Bulk) Voltage: 57.6V

Absorption Voltage: 56.5V

Float Voltage: 56V

Shut Down(cut off) Voltage: 48V

Shut Down(cut off) SOC: 20%

Restart Voltage: 52V

Max Charge Current:150A

Max Discharge Current: 150A

Power of Hybrid Inverter/ Off-grid Inverter	GSL Wall mounted battery system	
	Type	System Energy
10KW	1*GSL battery	16.38
20KW	2*GSL battery	32.76

5.3.10 Register on the website after installation

After the battery system installation is completed and the running is normal,you need to log in to the GSL ENERGY official website to register the product installation and use information to make the product warranty effective. Please follow the instructions on the website to register.

<http://www.gsl-energy.com> Service  Sign UP 

6. Use, maintenance and troubleshooting

6.1 Battery system usage and operation instructions

After completing the electrical installation, follow the instruction below to start the battery system.

1) Power on

Step 1 : Before turning on the battery, please make sure the DC breaker between battery and inverter is on "OFF" position.

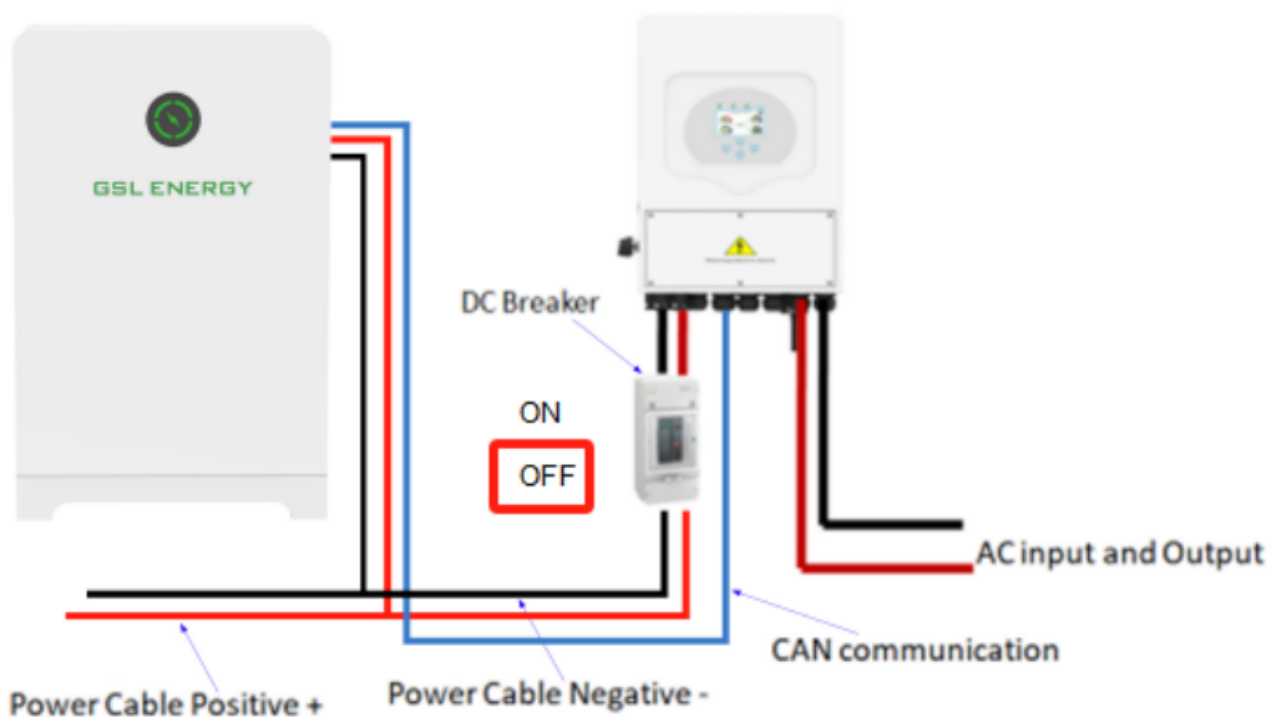

- Make sure battery positive and negative connect DC breaker +/- port .
- Red cable is for positive side; Black cable is for negative side.
- Make sure Coms cable connects inverter CAN port correctly.
- Make sure all the installation and operation must follow up local electric standard.

Step 2 Pull Battery DC breaker up to “ON” position. Battery positive and negative will be active then.

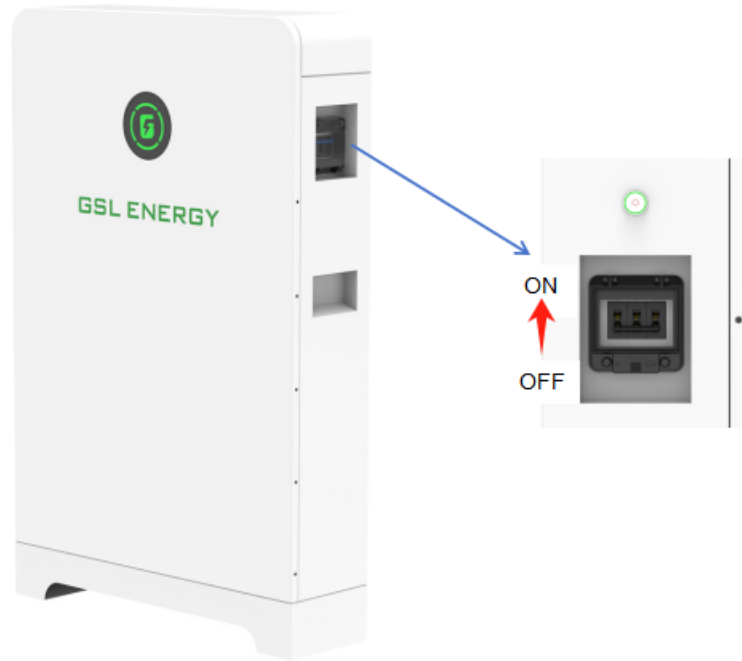

Step 3 Turn on Battery DC Switch , then LCD and LED will be flash at once, BMS is activated. Customer can check battery SOC, Voltage state on LCD.

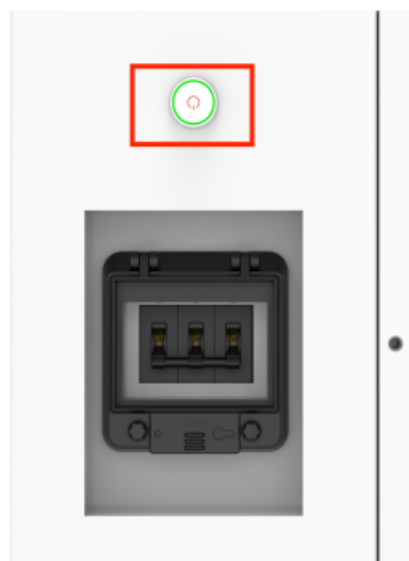

Step 4 Pull DC breaker to “ON” position on battery and outside DC breaker, then system can begin to work.

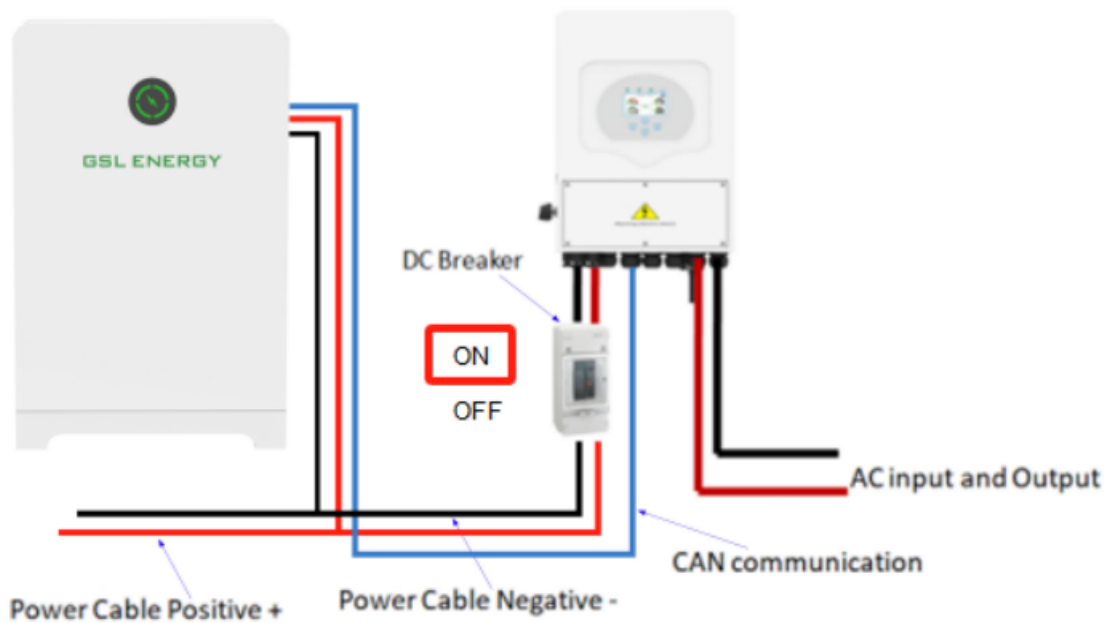

2) Power off

Step 1 Pull down DC breaker switch on “OFF” position

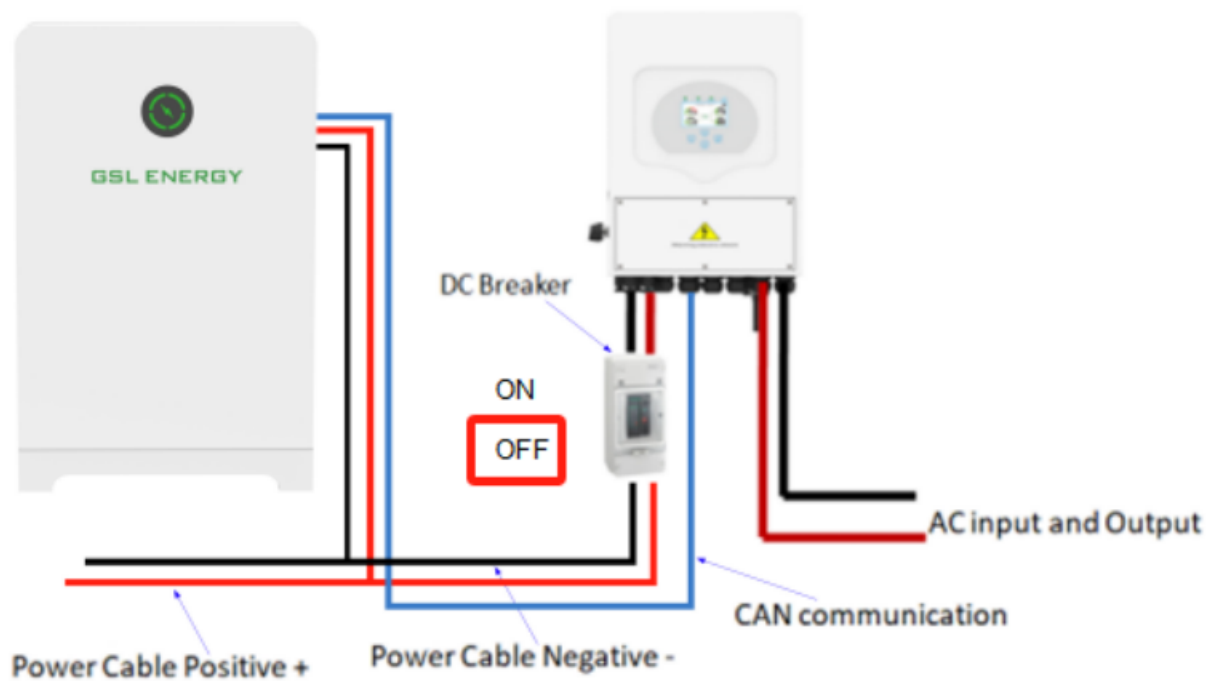

Step 2 Turn off Power switch to shut down BMS, LCD, LED finally.

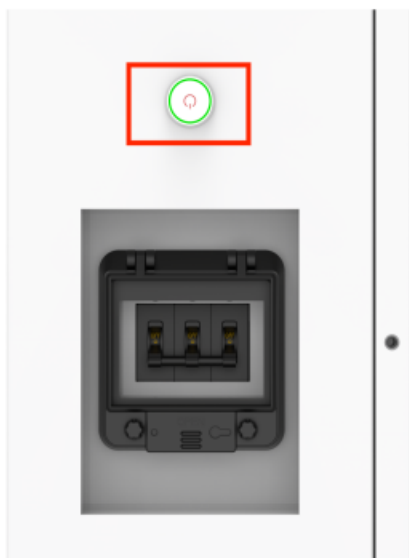

Step 3 Pull battery DC breaker at “OFF” position. Cut off battery positive and negative output.

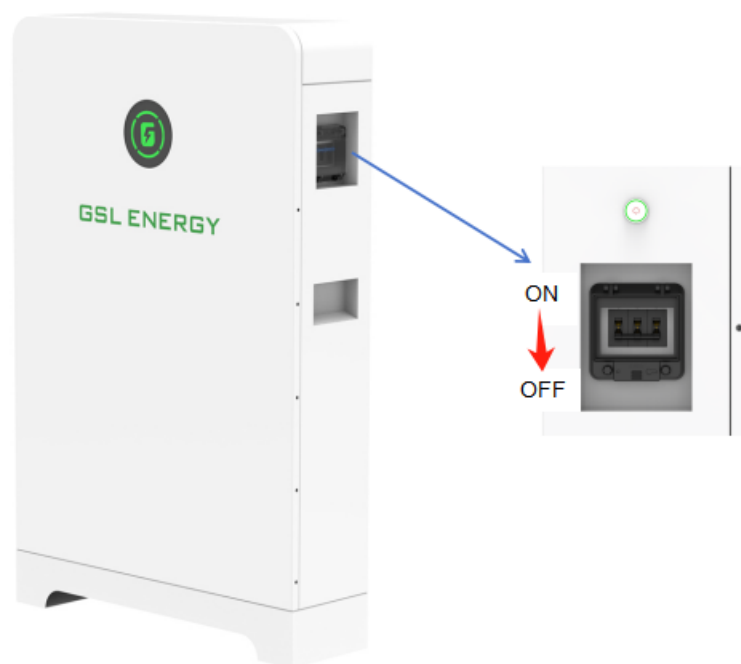



Caution

- After pressing the power button, if the battery status indicator lights shows abnormally, please refer to the "6.2 Alarm description and processing". If the failure cannot be eliminated, please contact the retailer timely.
- After pressing the power button, if the battery status indicator continues to be red, please refer to the "6.2 Alarm description and processing". If the failure cannot be eliminated, please contact the retailer timely.
- Use a voltmeter to measure whether the voltage across the BAT + / BAT- terminals of the inverter is higher than 44.8V, and check whether the voltage polarity is consistent with the input polarity of the inverter. If the voltage across the terminals BAT + / BAT- of the inverter is higher than 44.8V, which means the battery has begun to work normally.
- After confirm the battery output voltage and polarity are correct, turn on the inverter, then turn on the circuit breaker switch.
- Check whether the indicator light for the inverter and the battery connection (the communication indicator and the battery access status indicator) is in normal condition. If normal, the connection between the battery and the inverter is completed. If the indicator light shows abnormal, please check the inverter manual or contact the local dealer.

6.2 Alarm description and processing

When protection mode is activated or system failure occurred, the LED indicator on the front panel will alarm, through net management can query specific alarm class and take appropriate action.

6.2.1 Alarm and countermeasure for affecting system output

If there are any abnormalities affecting the output, such as battery cell in the battery module occurs over-current protection during charge/discharge, under-voltage protection, and temperature protection, in the system, please deal with them according to Table 6-1.

Table 6-1 Main alarm and Protection

State	Alarm category	Alarm indication	Processing
Charge state	Over-current when charging	RED light flashing Buzzer start	Reduce the charging current below the rated value.
	High temp protection	RED light flashing	Stop charging and find out the cause of the trouble.
Discharge State	Over-current protection when discharge	RED light flashing Buzzer start	Stop discharge and reduce discharge current below rated value.
	High temp protection when discharge	RED light Flash in	Stop discharging and find out the cause of the trouble.
	Over-discharged protection	RED light flashing Buzzer start	Start charging.
	Low voltage alarm	Yellow light on	Start charging.

6.2.2 Alarm and countermeasure for non-affecting system output

If a low SOC alarm occurs, the battery system also issues a corresponding alarm signal.

Maintainer should check the equipment according to the prompt information, determine the type and location of the fault, and take corresponding countermeasures to ensure that the system is in the best working condition to avoid affecting the system output. The phenomena and countermeasures are shown in Table 6-2.

Table 6-2 Minor alarm

Alert category	Alarm indication	Countermeasure
0<SOC<10%	System working status: RED light is always on	Stop discharge, and charge the battery system in time

6.2.3 Analysis and treatment of common faults

Table 6-3

Item	Fault phenomenon	Reason analysis	Solution
1	The indicator does not respond after power on the system	Make sure press and hold the power switch (Reset switch) for 3s.	Check the power switch
2	No DC output after power on the system	Check if the DC breaker is turned on	Check the status of the DC circuit breaker on the side of cabinet
3	No DC output and red light is ON,buzzer beeping	Battery voltage is too low	Charging the battery system
4	The battery cannot be fully charged	Charging voltage is too low	Adjust charging voltage within 57.1V~57.6V range
5	The power cable sparks once power on and ALM indicated Red light on	Power connection short-circuit	Turn off the battery, check the cause of the short circuit
6	The master power box Pro LED1 is yellow flashing	Communication fault between product and product, or between internal modules in battery.	Check the external communication cable firstly, Check the internal communication cable secondly
7	The led 1,2 don't stop changing alternately	Modules communication address distribution is fault	Check the external communication cable connection firstly. Check the slave module DIP setting.

If you need any technical help or have any question, please contact the dealer in time.

7. GSL Smart ESS APP Instructions

Download APP

iPhone: Search "GSL Smart ESS" in Apple Store.

Android: Search "GSL Smart ESS" in Google Play

7.1 Registration

Go to GSL SmartESS and register.

Click "Register" and create your account here.

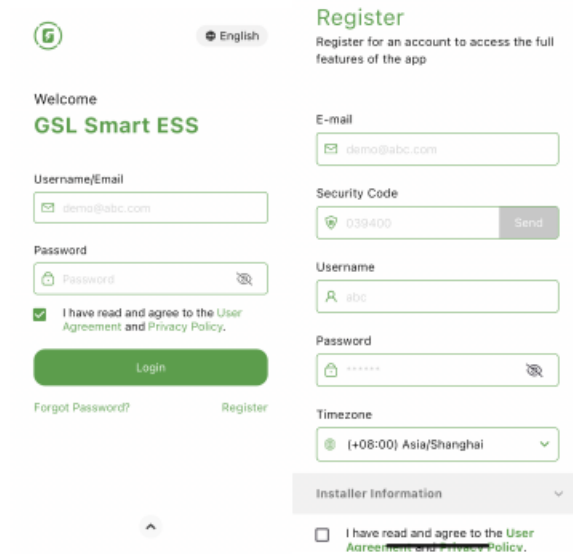

7.2 Create a Plant

Click "Create Plant" to create your plant.

Please fill in plant basic info and other info here.

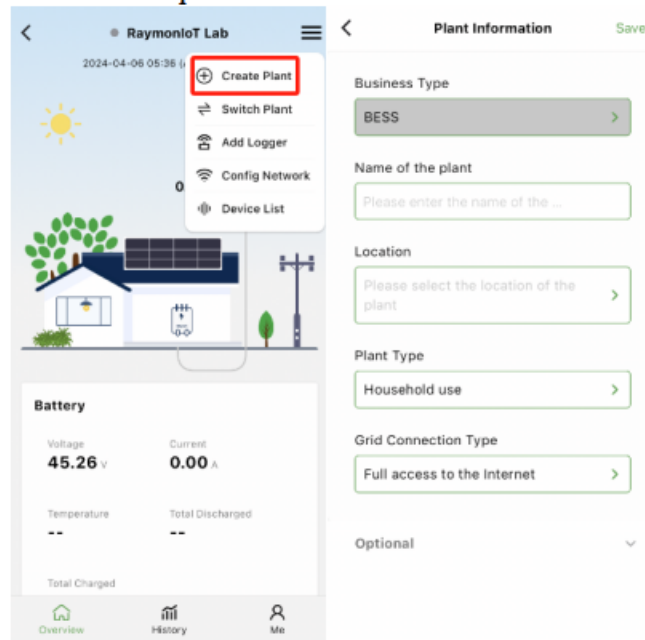

7.3 Add a Logger

Method 1: scan to enter logger SN, You can find logger SN in the external packaging or on the logger body.

Method 2: Enter logger SN manually

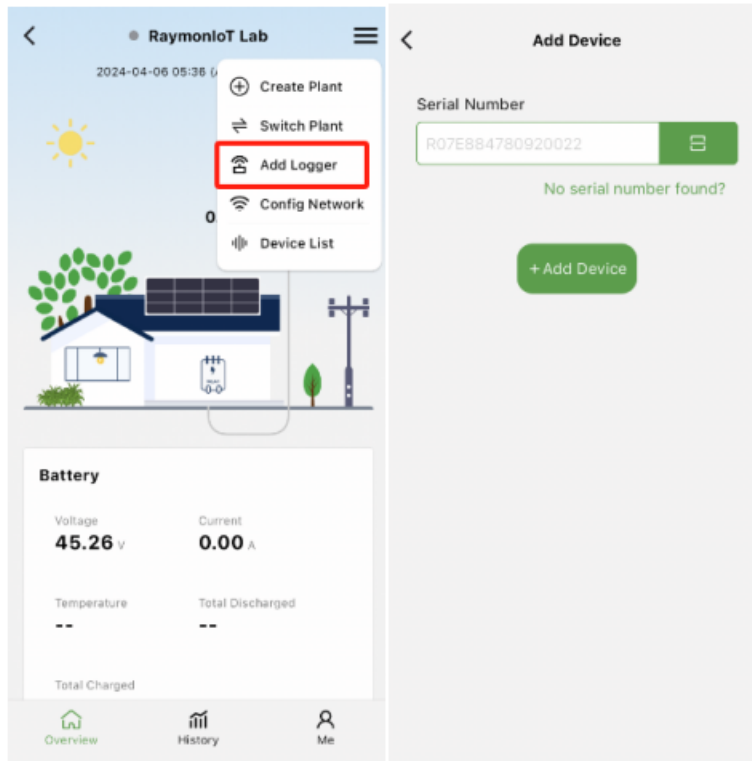

7.4. Network Configuration

Step 1: After the logger is added, please configure the network to ensure normal operation. Go to "Plant Details". "Config Network", find the target SN and click "Start Configuration".



Step 2: Confirm Wi-Fi info

Please make sure your phone has connected to the right WiFi network(2.4G). And click "Start Configuration". Then wait for the distribution to be successful

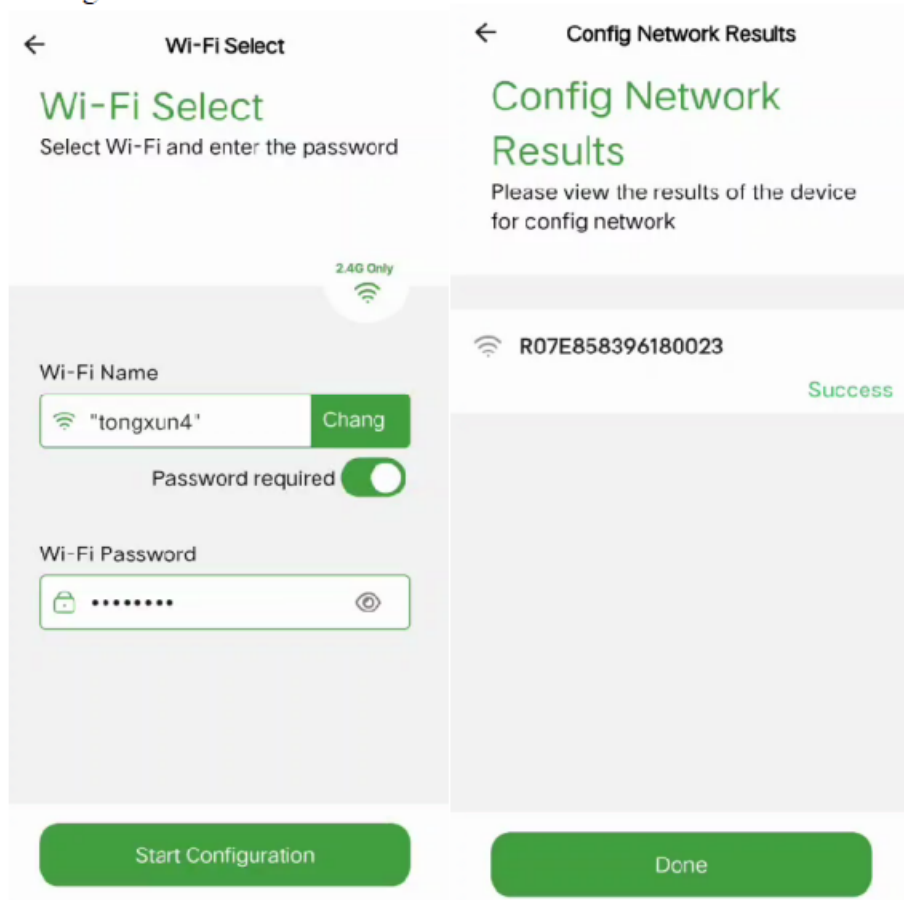

If you have any technical queries about our products, please contact us and provide the following information: 1. Product model and serial number of stick logger. 2. Product model and serial number of connected inverter. Thank you for your support and cooperation!

GSL ENERGY

SHENZHEN GSL ENERGY CO LTD

Head office : A602, Building 1, Tianan Cyber Park,
Long Gang Central City, Shenzhen ,
Guangdong, China

Factory address : Building #2 , 58 Xinjian Rd,
St. Qiuchang, Huiyang Distr. Huizhou,
Guangdong, China.

Web: www.gsl-energy.com

Tel : 86-755-84515360

After sales support : tech@gsl-energy.com